

Reflex Shower-toilet chair



5100 5600

Reflex Shower-toilet chair

Reflex, the all-round toilet and shower solution for disabled persons.



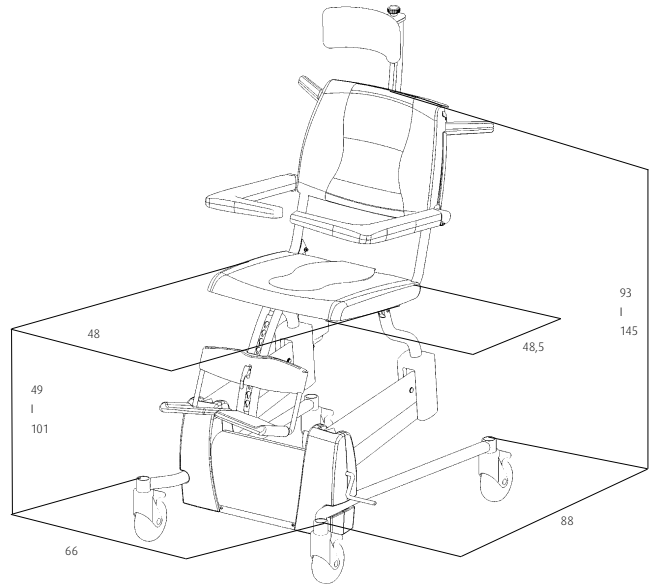

Reflex Shower-toilet chair

Characteristics

- Electrically operated height-adjustable settings (variable).
- Electrically operated tilt mechanism.
- Easy-to-use touch controls on backrest.
- Height-adjustable headrest.
- Ergonomically designed backrest and seat.
- Height-adjustable legrest and calf protection.
- Foldable swivel armrests with front locking.
- Suitable for use in the shower and toilet.
- Can be moved into position over toilet.
- Slide for stainless steel commode pan.
- Four plastic castors with brakes.
- Easy to recharge with battery charger provided.



Technical specifications

Maximum lifting capacity:	135 kilo / 298 lb
Adjustable sitting height:	49 – 101 cm
Backrest:	95 – 145 cm
Seat depth:	48.5 cm
Seat width:	48 cm
Overall length basic frame:	88 cm
Overall width basic frame:	66 cm
Adjustability of leg rests:	from 2.5 cm to 25 cm
Adjustable headrest:	7 depth / 12 height cm
Variable backrest adjustment:	30 degrees
Weight (unoccupied):	55 kg / 121 lb
Electric controls:	24 volt
Battery capacity:	7Ah
Number of lifting actions:	40 up-down movements with fully-charged batteries
Battery charger:	220 volt/50/60 Hz

Optional

- Also available with handcontrol.



Cornerstone Medical Inc. brings you the industry's best products from companies who focus their R&D to meet healthcare's evolving needs.



Cornerstone Medical Inc., 4-889 Barton Street, Stoney Creek, ON L8E 5V1
 T 905-945-2522 or 1-800-652-3895 | F 905-945-5611 | E info@cornerstone-medical.com

www.cornerstone-medical.com